

User Manual

Profinesse

Ref. KIT6715



PATENTED TECHNOLOGY

SW Version 1.9.0.R

1. INTRODUCTION

1.1. Product description

The Johansson Profinesse is a simplified programmable filter amplifier. The auto-programming functionality helps you to reduce setup time significantly. The Profinesse combines profiler intelligence with ultra compact housing and configuration flexibility

- Programmable terrestrial filter amplifier with 70 - 90 dB μ V output power
- **Auto-scan**
- **Ultra compact housing:** indoor and outdoor mounting
- 3 universal inputs: FM/VHF/UHF
- Can process and convert 32 channels
- Sharpest filters on the market (50 dB on adjacent channels)
- Real-time AGC on all individual multiplexes
- Flex matrix: complete flexibility in assigning filters

1.2. Typical installation

The Profinesse can be used to provide high quality TV signals in a wide range of projects, both in the hospitality as in the residential market. Typical buildings or infrastructures where the Profinesse can be used include, but are not limited to:

- Large and small hotels, hostels, bed and breakfasts, holiday parks
- Hospitals, rest homes, prisons, settlements
- Large and small multi-dwelling units

No part of this manual may be copied, reproduced, transmitted, transcribed or translated into any language without permission.

Unitron reserves the right to change the specifications of the hardware and software described in these manuals at any time.

Unitron cannot be held liable for any damages resulting from the use of this product. Specifications are subject to change without notice. 11/24

© Unitron - Frankrijklaan 27 - B-8970 Poperinge - Belgium

1.3. Hardware installation

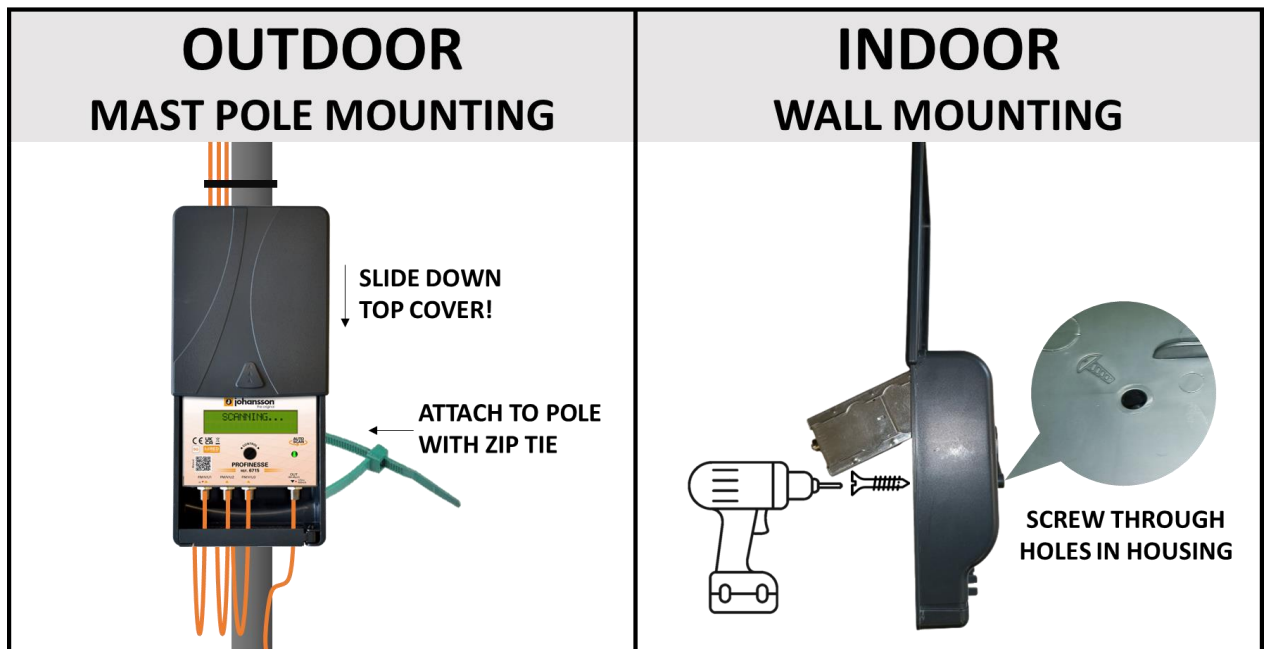
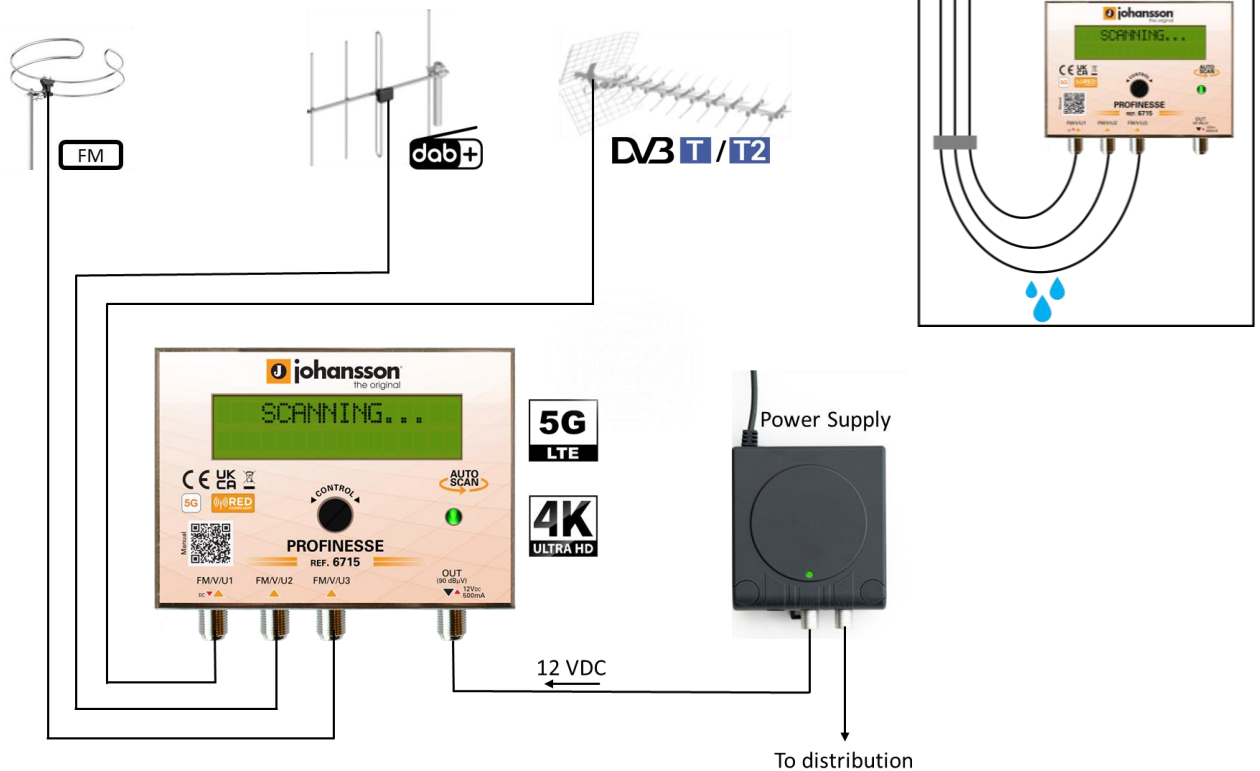

- The module can be mounted indoors (with screws) or to a mast pole (with a zip tie)
- Connect the inputs to the Profinesse
- Connect a coaxial cable to the output connector for distribution of the signal.
- Power the device via the output (use the Johansson Power Supply ref. 2438)

1.4. Configuring the Profinesse

NAVIGATING THROUGH THE MENU

Configure the device by turning the button with a flat screwdriver to navigate the menu. This is very straightforward and simple. The table below shows how the rotary/push should be used:

	<p>Push the button 2s to enter the basic configuration.</p> <p>When rotating the button, you scroll through the different screens.</p> <p>Push the button to confirm your selections.</p>
---	---

MENU OVERVIEW

◀▶	CHANNEL SCAN	INPUT FM/V/U1	INPUT FM/V/U2-3	OUTPUT	ADVANCED	EXIT	▶▶
	START	DC	ADD CHANNEL	LEVEL	LANGUAGE	LOCK	
◀▶	DUPLICATCH	ADD CHANNEL		VHF ATTN	REGION	NO LOCK	▶▶
					CONVERSION		
					BANDWIDTH		
					FW VERSION		
					SERIAL NUMBER		

REGION/COUNTRY SETTINGS





IMPORTANT! Before starting the configuration, it is advised to set the correct region or country. Unpower the unit, push the button and keep pushing the button while you repower the unit. Release the button when the display shows "RESET FINISHED". Now the product is reset and will ask you to enter country or region. This will amongst others determine the channel plan for VHF and UHF and the DC voltage (12V) for input 1.

DISPLAY READOUT	EXPLANATION
	<p>To activate the correct channel frequency plan, select the country or region where the Profinesse is situated. Rotate to select and confirm by tapping the rotary button.</p> <p>The default setting is Europe. The Profinesse is also operational in the following countries/regions: Australia, Brazil, China, Hongkong, Italia, New-Zealand, Russia, South Africa, UK and USA.</p>

All the following menu items can be accessed without the reset procedure.

Push the rotary button for 2 seconds to access the menu

CHANNEL SCAN

DISPLAY READOUT	EXPLANATION
	Tap the rotary button to enter the channel scan menu
	Scroll down to START and tap the rotary button to start scanning
	<p>Note: If you use an active antenna or mast amplifier the Profinesse activates the DC before doing the Channel Scan (for manual changes: see next page: DC)</p> <p>Scanning can take up to 1 minute</p>
	<p>When scanning is finished, the number of detected channels will be displayed. Manual changes can still be done afterwards via the Input settings (next section)</p> <p>Tap the rotary button to proceed in the menu</p> <p>Sometimes, there can be transponders on the same frequency coming from different antennas (e.g. CH21 is detected on input 1 and input 2). These are called duplicate channels.</p>
	<p>DUPLICATCH = When duplicate channels is ON, the weakest of a pair of duplicate channels will be transferred to the LTE band (CH50-69). The strongest of the pair keep its frequency at the output.</p> <p>When duplicate channels is OFF, the weakest of a pair of duplicate channels will be rejected.</p> <p>See next page for more details and explanation.</p>

Duplicate channel OFF:

Weakest channel is rejected. See example below:

- CH30 > CH30** → **CH30** is transmitted
- **CH30** is rejected
- CH40 < CH40** → **CH40** is rejected
- **CH40** is transmitted

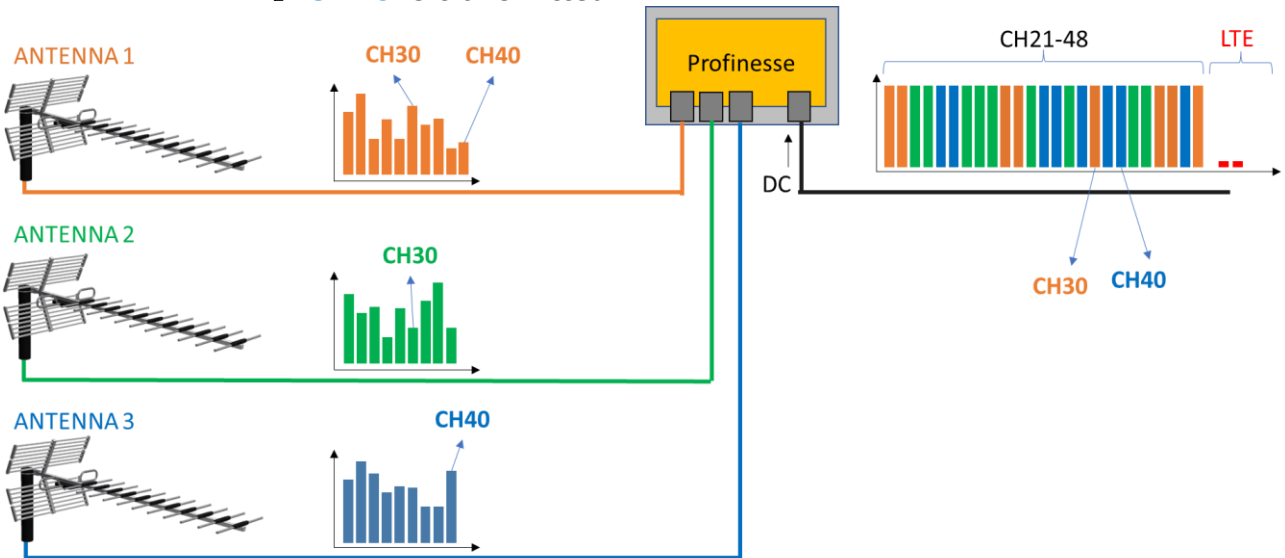





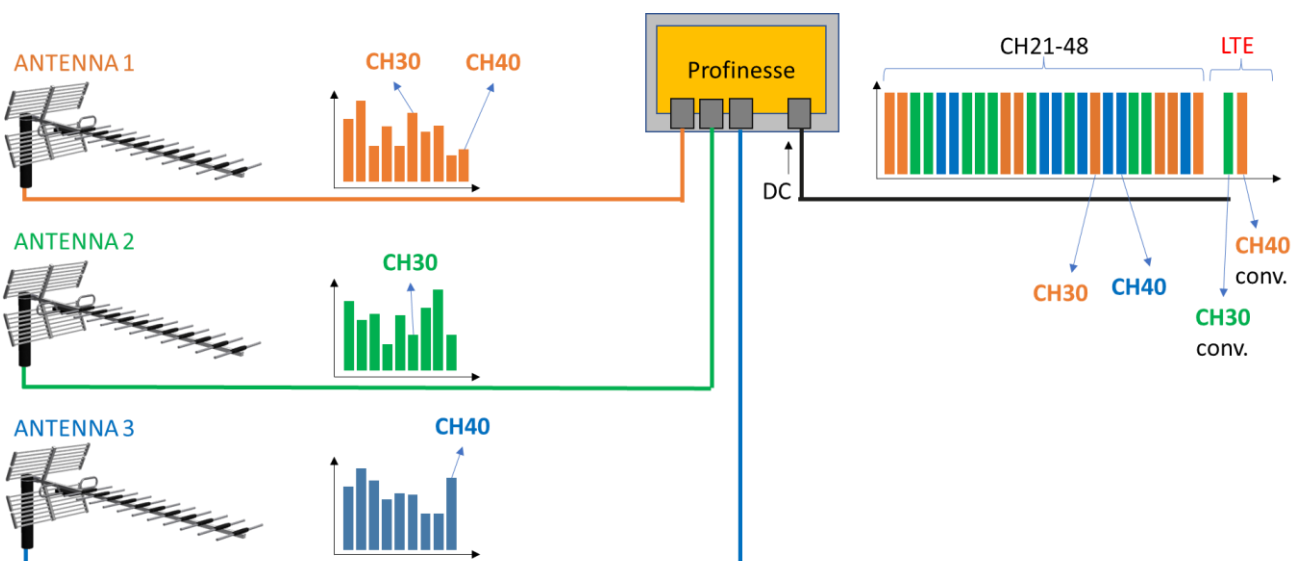

Duplicate channel ON:

Weakest channel is converted to LTE band. See example below:



- CH30 > CH30** → **CH30** is transmitted
- **CH30** is converted to LTE band
- CH40 < CH40** → **CH40** is converted to LTE band
- **CH40** is transmitted

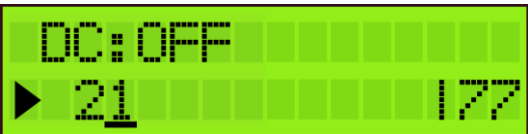



INPUT SETTINGS

DISPLAY READOUT	EXPLANATION
	Tap INPUT FM/V/U1 to enter the menu to configure input 1.
	Rotate the rotary button to scroll down in the submenu.
	DC: Decide whether the input should provide power to an external amplifier. Choose between OFF or 12 V.
	Tap Add Channel to add channel. First add the FM channel if applicable. By default, channel conversion is not active, but this can be activated in Advanced settings.
	Example of adding a channel without Channel conversion active. <u>Remark:</u> The value in the bottom right corner indicates the incoming level of the channel.
	Example of adding a channel with Channel conversion active. <u>Remark:</u> For EU, Italy and New-Zealand region, Channel 13 (230-240MHz) can be used. CH13 cannot be converted.
	If 2 channels are assigned to the same output channel, a star (*) will appear. Make sure that only one input channel is assigned to one output channel.



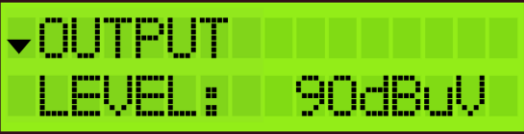

To delete a channel, position the arrow on the channel and press the rotary button 3 seconds.

DISPLAY READOUT	EXPLANATION
	To delete a channel, position the arrow on the channel and press the rotary button 3 seconds.
	When you have added all the channels to INPUT FM/V/U 1, and you want to add channels to the other inputs, scroll up to the top of the menu (to INPUT FM/V/U 1), tap the button and scroll to the next input. Repeat the previous steps for all input channels.



OUTPUT SETTINGS

DISPLAY READOUT	EXPLANATION
	<p>Define the OUTPUT LEVEL of the output signal. Range between 70 dBμV and 90 dBμV (default output level is 80 dBμV).</p>
	<p>VHF ATTN: To compensate for cable losses, an attenuator of up to 15 dB can be configured to decrease the VHF (up to 300MHz) output level (compared to the UHF output level (above 300MHz)).</p>

ADVANCED SETTINGS

DISPLAY READOUT	EXPLANATION
	<p>The LANGUAGE of the Profinesse can be set to English, Italian, Spanish or French.</p>
	<p>Tap REGION to check to which region/country the Profinesse is set. To change the region/country, a hard reset is required (see instructions above (cfr. REGION/COUNTRY SETTINGS)).</p>
	<p>Channel CONVERSION can be activated or deactivated here. When conversion is off, channels can be added faster in the input menus.</p>
	<p>The filter bandwidth (BW) can be changed from -2000 kHz to 0 kHz in steps of 250 kHz. This allows you to optimize the bandwidth of your filter. For instance, a European 8 MHz channel can be changed from 6 to 8 MHz. The default setting is -750 kHz, which is an optimal setting in 95% of the cases.</p>
	<p>Tap FW VERSION to check the firmware version of the device. Tap SERIAL NUMBER to check the serial number of the device.</p>

EXIT SETTINGS

DISPLAY READOUT	EXPLANATION
	To avoid unauthorized people changing the settings, all Profiler products can be locked with a security code.
	Select LOCK and SET LOCK CODE. When the lock code is set, the device will shut down.
	When you restart the device, you will now have to enter the correct lock code. <u>Remark:</u> If you forgot the lock code, you can always use the value 50. This master code is fixed and cannot be changed. If you do not want to work with a lock code, go to EXIT and tap NO LOCK.

2. BLOCK DIAGRAM

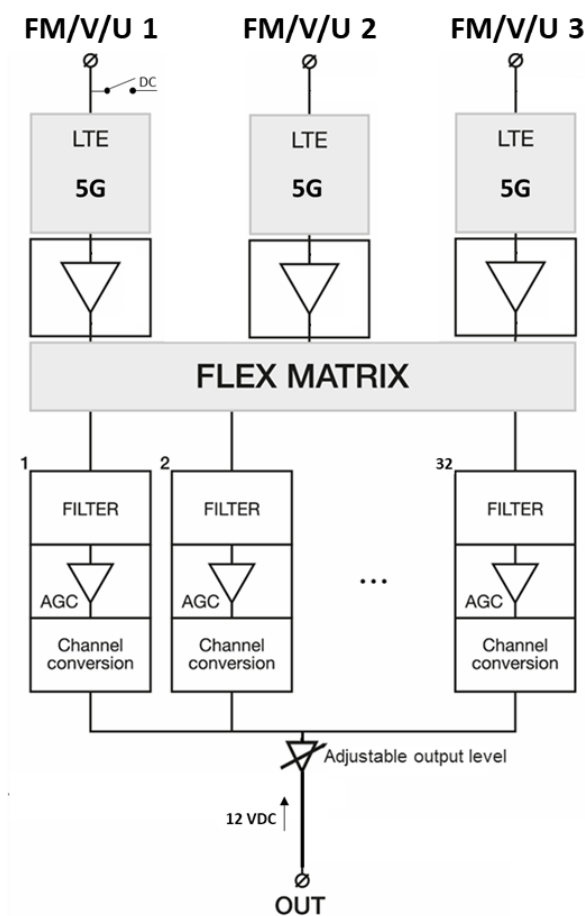

3. TECHNICAL SPECIFICATIONS

Profinesse 6715		
Inputs	-	3 x FM/VHF/UHF
Outputs	-	1
Input frequency range (EU*)	MHz MHz MHz	FM: 88 – 108 VHF: 174 – 240 UHF: 470 – 694
Output frequency range (EU*)	MHz	88 – 862
LTE protection	MHz	694 (5G)
Input level	dB μ V	35 - 105
VHF/UHF Output power (60dB/IM3)	dB μ V	70 - 90
Number of channel filters	-	32
Autoscan	-	Yes
Conversion	-	Yes (activate in advanced mode)
Gain	dB dB dB	FM: >50 VHF: >50 UHF: >50
Gain adjustment	dB	Channel AGC
General attenuator	dB	20
FM/VHF attenuator	dB	15
Noise figure	dB	7
Selectivity	dB/1MHz	50
Return Loss	dB	10
Output MER	dB dB	VHF: 35 UHF: 35
ESD protection	-	All inputs
Power to antenna	-	Yes, on input 1
Remote voltage for preamp	V	12
Remote current	mA	100
Operating temperature	°C	-20 to +50
Power Supply	V _{DC}	12V (use ref. 2438)
Power consumption	W	6
Dimensions	mm	82 x 98 x 32
Weight	kg	0,350

* Frequency range can vary slightly according to local channel plan (check REGION settings)

4. SAFETY INSTRUCTIONS



Read these instructions carefully before connecting the unit



To prevent fire, short circuit or shock hazard:

- Do not expose the unit to rain or moisture.
- Install the unit in a dry location without infiltration or condensation of water.
- Do not expose it to dripping or splashing.
- Do not place objects filled with liquids, such as vases, on the apparatus.
- If any liquid should accidentally fall into the cabinet, disconnect the power plug.



To avoid any risk of overheating:

- Install the unit in a well aired location and keep a minimum distance of 15 cm around the apparatus for sufficient ventilation
- Do not place any items such as newspapers, tablecloths, curtains, on the unit that might cover the ventilation holes.
- Do not place any naked flame sources, such as lighted candles, on the apparatus
- Do not install the product in a dusty place
- Use the apparatus only in moderate climates (not in tropical climates)
- Respect the minimum and maximum temperature specifications



To avoid any risk of electrical shocks:

- Connect apparatus only to socket with protective earth connection.
- The mains plug shall remain readily operable
- Pull out power plug to make the different connections of cables
- To avoid electrical shock, do not open the housing of adapter.



Maintenance



Only use a dry soft cloth to clean the cabinet.



Do not use solvent



For repairing and servicing refer to qualified personnel.



Dispose according to your local authority's recycling processes

5. CONDITIONS OF WARRANTY

Unitron N.V. warrants the product as being free from defects in material and workmanship for a period of 24 months starting from the date of production indicated on it. See note below.

If during this period of warranty the product proves defective, under normal use, due to defective materials or workmanship, Unitron N.V, at its sole option, will repair or replace the product. Return the product to your local dealer for reparation.

THE WARRANTY IS APPLIED ONLY FOR DEFECTS IN MATERIAL AND WORKMANSHIP AND DOES NOT COVER DAMAGE RESULTING FROM:

- Misuse or use of the product out of its specifications,
- Installation or use in a manner inconsistent with the technical or safety standards in force in the country where the product is used,
- Use of non-suitable accessories (power supply, adapters...),
- Installation in a defect system,
- External cause beyond the control of Unitron N.V. such as drop, accidents, lightning, water, fire, improper ventilation...

THE WARRANTY IS NOT APPLIED IF

- Production date or serial number on the product is illegible, altered, deleted or removed.
- The product has been opened or repaired by a non-authorized person.

NOTE

Date of production can be found in the product's serial number code. The format will either be "YEAR W WEEK" (e.g., 2017W32 = year 2017 week 32) or "YYWW" (e.g., 1732 = year 2017 week 32).



www.unitrongroup.com

UNITRON NV
Frankrijklaan 27
B-8970 Poperinge
Belgium

T +32 57 33 33 63

sales@unitrongroup.com

www.unitrongroup.com